

IDS Series

Pompe a Membrana - Diaphragm Pumps

IDS 1000

550 RPM

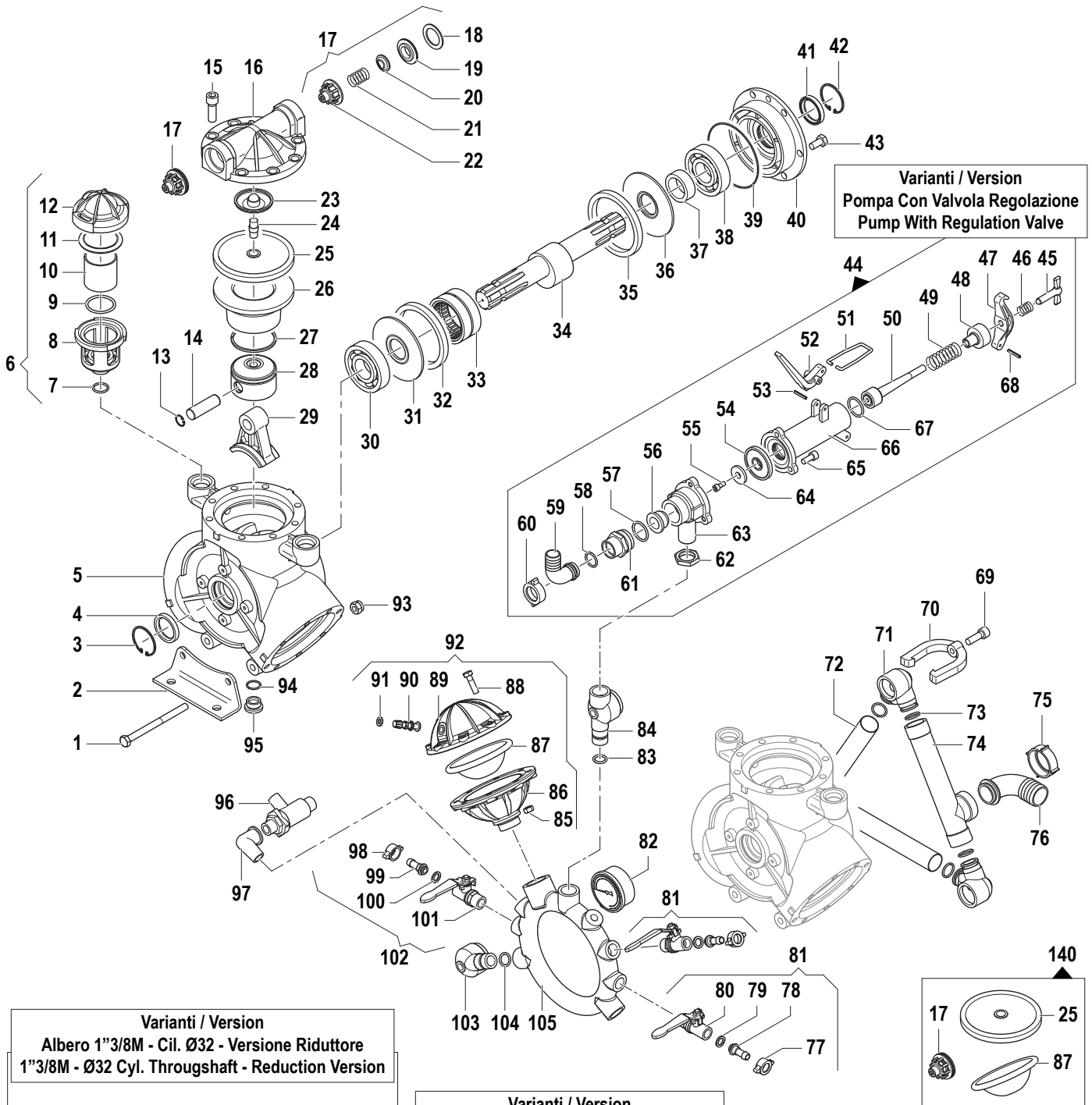

Varianti / Version
Pompa Con Valvola Regolazione
Pump With Regulation Valve

Varianti / Version
Albero 1"3/8M - Cil. Ø32 - Versione Riduttore
1"3/8M - Ø32 Cyl. Throughshaft - Reduction Version

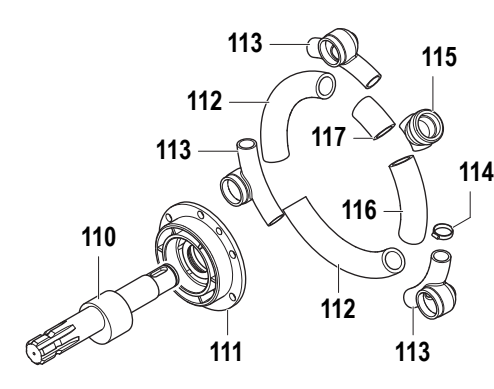

Varianti / Version
Albero Femmina 1"3/8M - 1"3/8F - 6 Fori
1"3/8M - 1"3/8F - 6 Holes Throughshaft

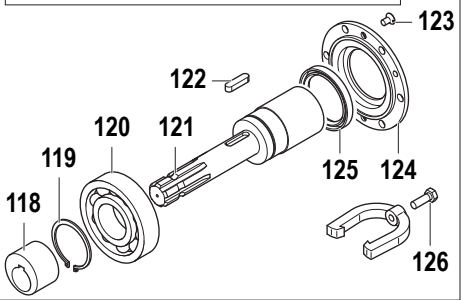

Kit / Optional
Kit Puleggia
Pulley Kit

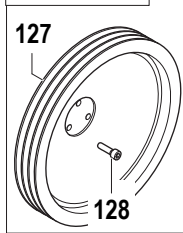

Kit / Optional
Kit Puleggia
Pulley Kit

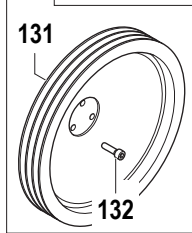

Pompa Base
Standard Pump

Albero Passante 1"3/8 M-M
1"3/8 M-M Throughshaft

IDS 1000

N°	Cod.	Descrizione	Description	Note	Qty	Model
1	3607 0144	Vite Testa Esagonale	Hexagonal Screw	M10x130	2	
2	2400 0010	Piede Sostegno Pompa	Pump Mounting Bracket		2	
3	3020 0009	Seeger Interno	Inner Seeger	Ø47	1	
4	0019 0083	Anello Tenuta	Oil Seal	Ø35x47x7	1	
5	0403 0136	Carter Pompa	Pump Crankcase		1	
6	1208 0002	Gruppo Compens. Volum.	Volumetric Compensator Kit		2	
7	1210 0002	Guarnizione OR	O-Ring	Ø2,62x20,7	2	
8	0421 0004	Compensatore Volumetrico	Volumetric Compensator		2	
9	1210 0030	Guarnizione OR	O-Ring	Ø3,53x39,69	2	
10	1809 0001	Murata Compens. Volum.	Holder		2	
11	1800 0001	Membrana Compens. Volum.	Volum. Comp. Diaphragm		2	
12	0402 0522	Coperchio Compens. Volum.	Volum. Compensator Cover		2	
13	3020 0006	Seeger Interno	Inner Seeger	Ø18	6	
14	3011 0003	Spinotto	Gudgeon Pin	Ø18x57	3	
15	3609 0091	Vite	Screw	M12x35	24	
16	3218 0009	Testata Pompa	Pump Manifold		3	
17	1220 0010	Gruppo Valvola Asp./Mand.	Suct./Delivery Valve Ass.y kit		6	
18	1209 0043	Guarnizione	Gasket	Ø29x42x1,8	6	
19	3009 0123	Sede Valvola Aspir./Mand.	Suction/Delivery Valve Seat		6	
20	3604 0009	Valvola Aspiraz./Mandata	Suction/Delivery Valve		6	
21	1802 0015	Molla (Filo Ø0,8)	Spring (Wire Ø0,8)	Øe11x17	6	
22	1205 0005	Gabbia Valvola Aspir./Mand.	Suction/Delivery Valve Cage		6	
23	0602 0011	Disco Tenuta Membrana	Disc		3	
24	2419 0042	Prigioniero	Stud Bolt	12MBx30/11x11	3	
25	1800 0012	Membrana Pompa	Diaphragm	Gomma Nitrilica Buna Rubber	3	
	1800 0058	Membrana Pompa	Diaphragm	Desmopan ®	3	
	1800 0031	Membrana Pompa	Diaphragm	Viton ®	3	
26	0400 0016	Camicia	Piston Sleeve	Ø70	3	
27	0200 0001	Anello Compressione	Compression Ring	Ø70x3x2,8	3	
28	2409 0068	Pistone Guida	Piston	Ø70	3	
29	0205 0022	Kit Biella 3SET	Connecting Rod Assembly		1	
30	0438 0012	Cuscinetto a Sfere	Ball Bearing	Ø35x80x21	1	
31	2813 0005	Rondella Tenuta Biella	Connecting Rod Washer	Ø35,5x108x4	1	
32	0010 0003	Anello Tenuta Biella	Connecting Rod Ring	Ø109,5x93x10	1	
33	0437 0004	Cuscinetto Rulli	Roller Bearing	Ø60x78x40	1	
34	0001 0468	Albero Passante	Throughshaft	1"3/8 M-M	1	
35	0010 0003	Anello Tenuta Biella	Connecting Rod Ring	Ø109,5x93x10	1	
36	2813 0005	Rondella Tenuta Biella	Connecting Rod Washer	Ø35,5x108x4	1	
37	0601 0046	Distanziale	Spacer	Ø35,5x48	1	
38	0438 0012	Cuscinetto a Sfere	Ball Bearing	Ø35x80x21	1	
39	1210 0389	Guarnizione OR	O-Ring	Ø1,78x107,67	1	
40	0405 0020	Coperchio Supp. porta Cusc.	Support Cover		1	
41	0019 0083	Anello Tenuta	Oil Seal	Ø35x47x7	1	
42	3020 0009	Seeger Interno	Inner Seeger	Ø47	1	
43	3607 0225	Vite Testa Esagonale	Hexagonal Screw	M10x20	6	
44	1215 0287	Gruppo Valvola Regolazione	Regulation Valve Assembly		1	
45	3605 0003	Vite Speciale Galletto	Wing Nut Screw		1	
46	1802 0010	Molla (Filo Ø2)	Spring (Wire Ø2)	Øe15x28	1	
47	0208 0002	Bilancere Valvola Regolaz.	Lever		1	
48	0432 0022	Cappellotto Premi Molla	Special Cap		1	
49	1802 0085	Molla	Spring	Øe34x18	1	
50	0015 0068	Asta Valvola Regolazione	Regulation Valve Rod		1	
51	1202 0002	Gancio Valvola Regolaz.	Hook		1	
52	1600 0014	Leva Valvola Regolazione	Lever		1	
53	3021 0011	Spina Elastica	Elastic Pin	Ø4x26	1	
54	1800 0039	Membrana Valvola Regolaz.	Regulation Valve Diaphragm		1	
55	3609 0047	Vite	Screw	M6x14	1	
56	3009 0042	Sede Valvola Pressione	Pressure Valve Seat		1	
57	1210 0033	Guarnizione OR	O-Ring	Ø3x28	1	
58	1210 0002	Guarnizione OR	O-Ring	Ø2,62x20,7	1	
59	2801 0004	Raccordo p.g. Rifuto Curvo	Elbow Tail	Ø18x23	1	
60	1200 0005	Galletto	Wing Nut	30MB	1	
61	2000 0012	Niplo	Nipple	M36x2 - M30x2	1	
62	0604 0050	Dado	Nut	G3/4"x7	1	
63	0424 0072	Corpo Infer. Valvola Regol.	Regulation Valve Body		1	
64	3600 0020	Valvola Pressione	Pressure Valve		1	
65	3609 0157	Vite	Screw	M8x18	3	
66	0424 0077	Corpo Super. Valvola Regol.	Regulation Valve Body		1	
67	1210 0033	Guarnizione OR	O-Ring	Ø3x28	1	
68	3021 0011	Spina Elastica	Elastic Pin	Ø4x26	1	
69	3609 0160	Vite	Screw	M10x30	6	
70	0418 0004	Cavallotto	U-Bolt		6	
71	2804 0005	Raccordo Curvo Aspirazione	Elbow Suction Coupling		3	
72	3213 0001	Tubo Aspirazione	Suction Hose		2	
73	1210 0020	Guarnizione OR	O-Ring	Ø3,53x20,22	6	
74	3212 0004	Tubo Aspirazione a "T"	"T" Suction Hose		1	

550 RPM

N°	Cod.	Descrizione	Description	Note	Qty	Model
75	1200 0004	Galletto	Wing Nut	M46x2 - Ø35	1	
76	2801 0001	Raccordo p.g. Aspir. Curvo	Suction Elbow Tail	Ø27x35	1	
77	1200 0038	Galletto	Wing Nut	G1/2"	2	
78	2802 0018	Raccordo p.g. Mandata	Delivery Hose Tail	Ø8x10	1	
79	1209 0013	Guarnizione	Gasket	Ø12x18x2	2	
80	2826 0032	Rubinetto DX	Right Tap	G1/2-1/2"	2	
81	1214 0017	Gruppo Rubinetto DX	Complete Right Tap		2	
82	1816 0118	Manometro	Pressure Gauge	SR 50 bar 1/4"	1	
83	1210 0003	Guarnizione OR	O-Ring	Ø3x16,2	1	
84	2806 0017	Raccordo Mandata per Valv.	Delivery Hose Tail for Valve		1	
85	0604 0039	Dado	Nut	M8	8	
86	0002 0008	Accumulatore Press. Infer.	Pressure Accumulator		1	
87	1800 0034	Membrana Accumulatore	Diaphragm		1	
88	3607 0070	Vite Testa Esagonale	Hexagonal Screw	M8x30	8	
89	0003 0018	Accumulatore Press. Sup.	Pressure Accumulator		1	
90	3610 0003	Valvola Aria	Air Valve		1	
91	1209 0033	Guarnizione	Gasket	Ø14x7,5x2	2	
92	0102 0020	Kit Accumulatore Pressione	Pressure Accumulator Kit		1	
93	0604 0038	Dado	Nut	M10	2	
94	1210 0209	Guarnizione OR	O-Ring	Ø2x19	1	
95	3200 0001	Tappo Esagonale	Plug	22MB	1	
96	1219 0041	Gruppo Valvola Sicurezza	Safety Valve Assembly	50 bar 100-150L	1	
97	1211 0012	Gomito	Elbow		1	
98	1200 0038	Galletto	Wing Nut	G1/2"	1	
99	2802 0018	Raccordo p.g. Mandata	Delivery Hose Tail	Ø8x10	1	
100	1209 0013	Guarnizione	Gasket	Ø12x18x2	1	
101	2826 0031	Rubinetto SX	Left Tap	G1/2-1/2"	1	
102	1214 0016	Gruppo Rubinetto SX	Complete Left Tap		1	
103	2806 0013	Raccordo Mandata	Delivery Hose Tail		2	
104	1210 0003	Guarnizione OR	O-Ring	Ø3x16,2	2	
105	0415 0008	Collettore Mandata	Delivery Manifold		1	

Varianti

Version

110	0001 0046	Albero	Shaft	1"3/8M-Ø32 Cil.	1	
111	0405 0045	Flangia Porta Paraolio	Flange		1	
112	3213 0007	Tubo Aspirazione	Suction Hose		2	
113	2804 0006	Raccordo Curvo Aspiraz.	Elbow Suction Coupling		3	
114	1003 0024	Fascetta	Hose Clamp		8	
115	3212 0011	Raccordo Curvo Asp. "T"	"T" Elbow Suct. Coupling		1	
116	3213 0008	Tubo Aspirazione	Suction Hose		1	
117	3213 0009	Tubo Aspirazione	Suction Hose		1	

Varianti

Version

118	0800 0004	Eccentrico	Eccentric		1	
119	3019 0005	Seeger esterno	External Seeger		1	
120	0438 0013	Cuscinetto a Sfere	Ball Bearing	Ø65x120x23	1	
121	0004 0023	Albero	Shaft	1" 3/8 - 6F	1	
122	1602 0020	Linguetta	Key	10x8x40	1	
123	3621 0004	Vite Speciale	Special Screw	M8x14	2	
124	1004 0002	Flangia Porta Paraolio	Flange		1	
125	0019 0001	Anello Tenuta	Oil Seal	Ø68x90x10	1	
126	3607 0220	Vite Testa Esagonale	Hexagonal Screw	M10x30	3	

Kit

Optional

127	2424 0012	Puleggia	Pulley	3B - Øp292	1	
128	3607 0227	Vite Testa Esagonale	Hexagonal Screw	M10x40	3	
129	5001 0027	Kit Puleggia	Pulley Kit	3B - Øp292	1	

Kit

Optional

130	5001 0028	Kit Puleggia	Pulley Kit	3A - Øp350	1	
131	2424 0005	Puleggia	Pulley	3A - Øp350	1	
132	3609 0009	Vite	Screw	M10x35	3	

Kit Manutenzione

Maintenance Kit

140	5026 0093	Kit Manutenzione Ordinaria	Ordinary Maintenance Kit		1	
-----	-----------	----------------------------	--------------------------	--	---	--