

# BP 330 HS



POMPE A MEMBRANA A BASSA PRESSIONE  
LOW PRESSURE DIAPHRAGM PUMPS  
POMPES A MEMBRANE A BASSE PRESSION  
BOMBAS A MEMBRANA DE BAJA PRESSION  
NIEDERDRUCK-MEMBRANPUMPEN



Configurazione: 6 membrane in NBR e Desmopan® (Viton a richiesta). Parti a contatto con il liquido: alluminio plastificato. A richiesta: valvola di sicurezza, protezione p.d.f.. Elevata velocità di rotazione per trattori con p.d.f. a 1000 RPM, con bassi consumi di carburante operando a 800 RPM.

Configuration: 6 diaphragms in NBR and Desmopan® (Viton available on request). Parts in contact with spray liquid: plastic coated aluminium. On request: safety valve and PTO protection. High speed for tractors with PTO and 1000 RPM with low fuel consumption operating at 800 RPM.

Configuration: 6 membranes en NBR et Desmopan® (Viton à la demande). Parties au contact du liquide: aluminium plastifié. À la demande: soupape de sécurité, protection prise de force. Vitesse de rotation élevée pour tracteurs avec prise de force à 1000 tours/minute, consommation de carburant contenue au régime de 800 tours/minute.

Configuración: 6 membranas en NBR y Desmopan® (Viton bajo pedido). Partes en contacto con el líquido: aluminio plastificado. Bajo pedido: válvula de seguridad, protección toma de fuerza (t.d.f.). Velocidad de rotación elevada para tractores con t.d.f. a 1000 r.p.m. con un bajo consumo de carburante trabajando a 800 r.p.m.

Konfigurierung: 6 Membranen aus NBR und Desmopan® (Viton auf Wunsch). Teile im Kontakt mit der Flüssigkeit: plastifiziertes Aluminium. Auf Wunsch: Sicherheitsventil und Zapfwellenschutz, Hohe Rotationsgeschwindigkeit für Traktoren mit Zapfwelle bei 1000 UpM, mit niedrigem Kraftstoffverbrauch beim Arbeiten mit 800 UpM.

## BP 330 HS

RPM	0 bar - 0 p.s.i				5 bar - 72 p.s.i				10 bar - 145 p.s.i				15 bar - 217 p.s.i				20 bar - 290 p.s.i				kg / lb	
	l/min	U.S.g.p.m.	HP	kW	l/min	U.S.g.p.m.	HP	kW	l/min	U.S.g.p.m.	HP	kW	l/min	U.S.g.p.m.	HP	kW	l/min	U.S.g.p.m.	HP	kW		
650	282	74	2,4	1,8	280	74	4,1	3,0	278	73	7,5	5,5	275	73	10,6	7,8	273	72	14,0	10,3	50	110
700	305	81	3,1	2,3	301	80	4,6	3,4	299	79	8,2	6,0	296	78	11,6	8,5	295	78	15,4	11,3		
750	324	86	3,7	2,7	321	85	5,2	3,8	317	84	8,8	6,5	315	83	12,5	9,2	314	83	16,6	12,2		
800	341	90	4,4	3,2	339	90	5,7	4,2	338	89	9,7	7,1	337	89	13,6	10,0	335	88	17,8	13,1		

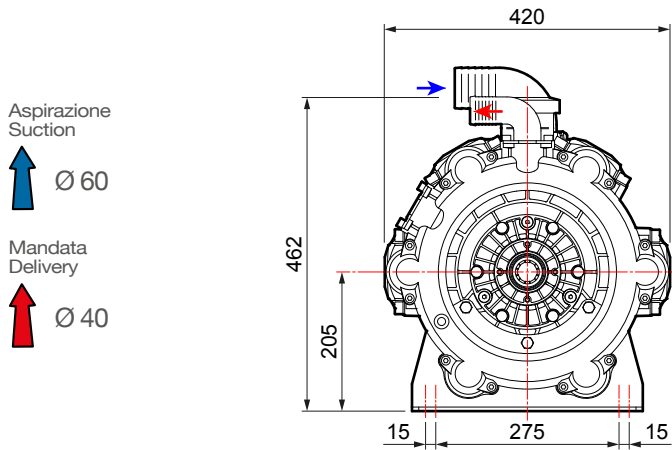

Aspirazione  
Suction



Ø 60

Mandata  
Delivery



Ø 40

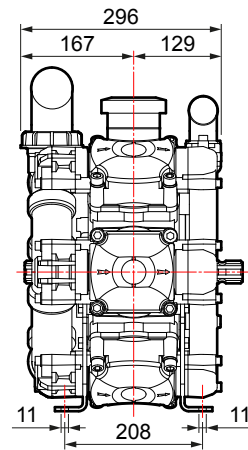

**VERSIONI STANDARD · STANDARD VERSIONS · VERSIONS STANDARD · VERSIONES ESTÁNDAR · STANDARDAUSFÜHRUNGEN**

Versioni derivate · Versions adapted · Versions dérivées · Versiones derivadas · Von der Standardversion abgeleitete Ausführungen

**A**



Albero passante  
Through shaft  
Arbre traversant  
Cigüeñal pasante  
Durchgangswelle

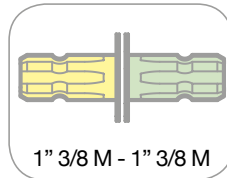

1" 3/8 M - 1" 3/8 M

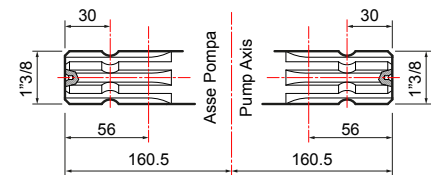

**1**



Flangiata a motore idraulico  
Flanged to hydraulic motor  
Bridée à un moteur hydraulique  
Conexión con brida a motor hidráulico  
An Hydraulikmotor geflanscht

**2**



Flangiata a pompa idraulica  
Flanged to hydraulic pump  
Bridée à une pompe hydraulique  
Conexión con brida a bomba hidráulica  
An Hydraulikpumpe geflanscht

**3**

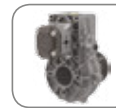

Moltiplicatore per pompa idraulica  
Overgear box for hydraulic pump  
Multiplicateur pour pompe hydraulique  
Multiplicador para bomba hidráulica  
Übersetzungsgetriebe für Hydraulikpumpe

**B**



Albero passante  
Through shaft  
Arbre traversant  
Cigüeñal pasante  
Durchgangswelle

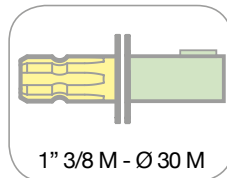

1" 3/8 M - Ø 30 M

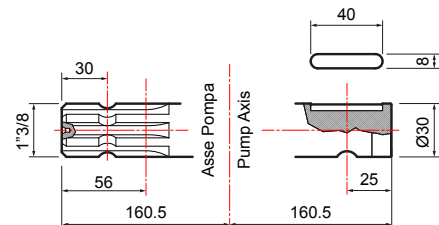

**1**



Flangiata a motore idraulico  
Flanged to hydraulic motor  
Bridée à un moteur hydraulique  
Conexión con brida a motor hidráulico  
An Hydraulikmotor geflanscht

**2**



Flangiata a pompa idraulica  
Flanged to hydraulic pump  
Bridée à une pompe hydraulique  
Conexión con brida a bomba hidráulica  
An Hydraulikpumpe geflanscht

**C**



Albero passante \*  
Through shaft \*  
Arbre traversant \*  
Cigüeñal pasante \*  
Durchgangswelle \*

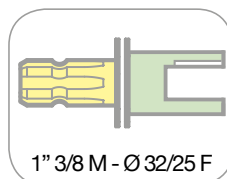

1" 3/8 M - Ø 32/25 F

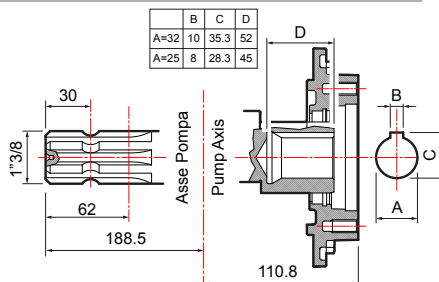

**1**



Flangiata a motore idraulico\*\*  
Flanged to hydraulic motor\*\*  
Bridée à un moteur hydraulique\*\*  
Conexión con brida a motor hidráulico\*\*  
An Hydraulikmotor geflanscht\*\*

**2**



Flangiata a pompa idraulica  
Flanged to hydraulic pump  
Bridée à une pompe hydraulique  
Conexión con brida a bomba hidráulica  
An Hydraulikpumpe geflanscht

**3**



Moltiplicatore per pompa idraulica  
Overgear box for hydraulic pump  
Multiplicateur pour pompe hydraulique  
Multiplicador para bomba hidráulica  
Übersetzungsgetriebe für Hydraulikpumpe

\* = Ø32 oppure Ø25 / Ø32 or Ø25 / Ø32 ou Ø25 / Ø32 o bien Ø25 / Ø32 oder Ø25

\*\* = flangiata diretta sulla pompa / directly flanged on the pump / bridée directement à la pompe / conexión con brida directa a la bomba / direkt an die Pumpe geflanscht