

# IDS Series

Pompe a Membrana - Diaphragm Pumps

IDS 1400

550 RPM

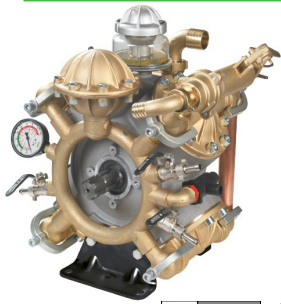

6030005100  
6030005200  
6030005300  
6030005400  
6030005500  
6030005600

IDS1400 1"3/8 M-M VR GVS (SERIE)  
IDS1400 1"3/8 M-F VR GVS (SERIE)  
IDS1400 1"3/8 M RID VR GVS (SERIE)  
IDS1400 1"3/8 M-M S VR GVS (SERIE)  
IDS1400 1"3/8 M-F S VR GVS (SERIE)  
IDS1400 1"3/8 M RID S VR GVS (SER)

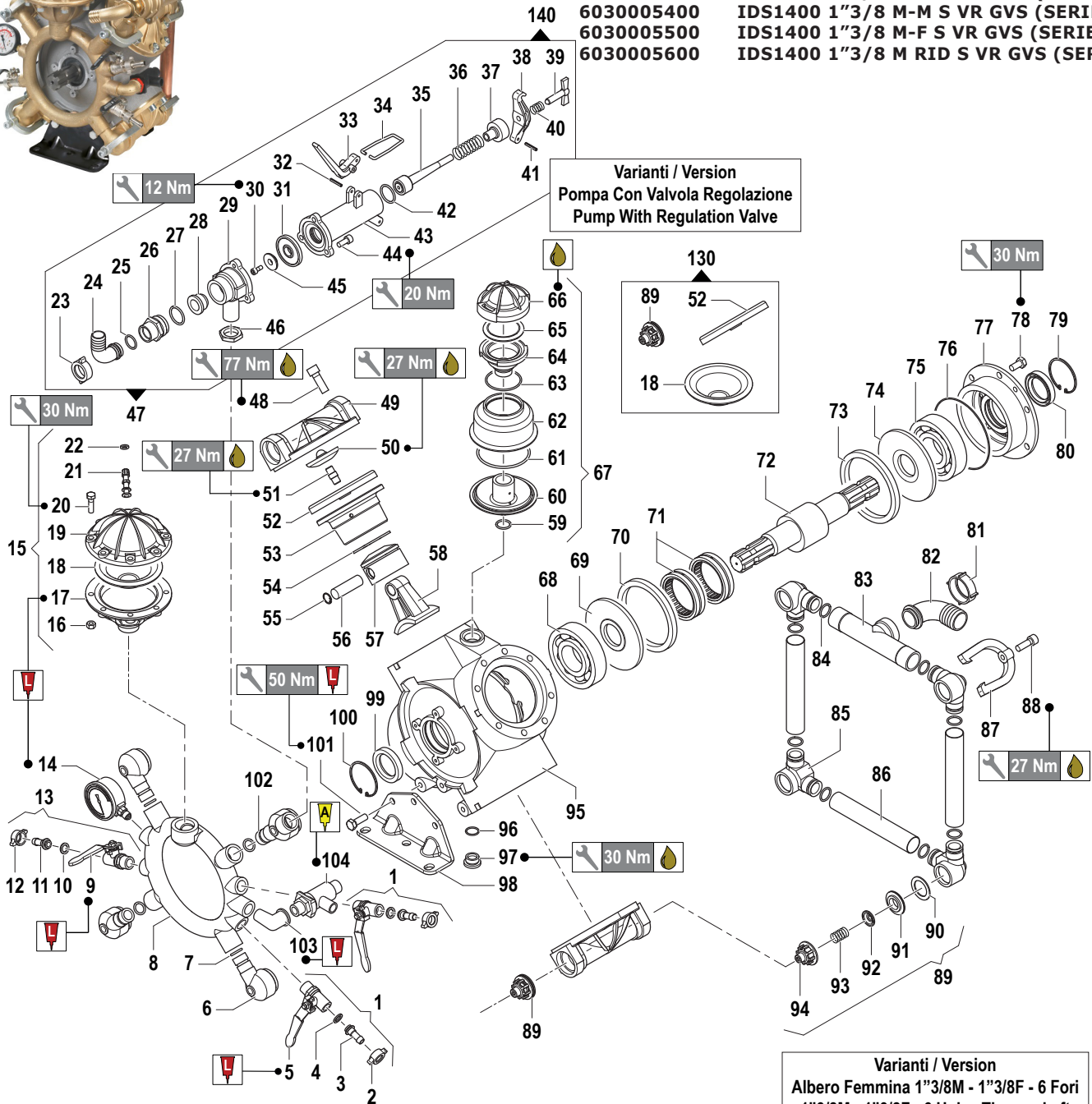

Varianti / Version  
Pompa Con Valvola Regolazione  
Pump With Regulation Valve

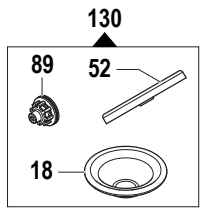

Varianti / Version  
Albero Femmina 1"3/8M - 1"3/8F - 6 Fori  
1"3/8M - 1"3/8F - 6 Holes Throughshaft

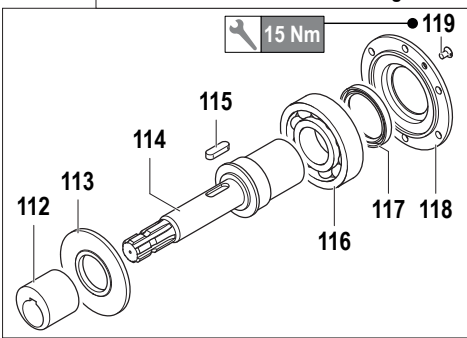

Varianti / Version  
Albero 1"3/8M - Cil. Ø32 - Versione Riduttore  
1"3/8M - Ø32 Cyl. Throughshaft - Reduction Version

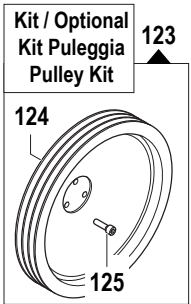
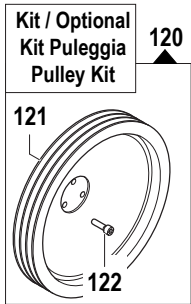
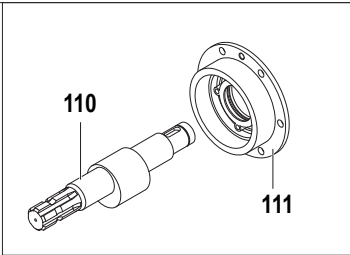

o equivalente  
or equivalent

Adesivo  
Adhesive

LOCTITE  
EA 9466

Frenafletti  
Threadlocker

LOCTITE  
243

Mastice  
Mastic

AREXONS  
0019

Grasso  
Grease

AGIP  
GR MU 3

Coppia di serraggio (usare chiave dinamometrica)  
Tightening Torque (use torque wrench)

Legenda  
Legend

Pompa Base  
Standard Pump

Albero Passante 1"3/8 M-M  
1"3/8 M-M Throughshaft

### IDS 1400

N°	Cod.	Descrizione	Description	Note	Qty	Model
1	1214 0017	Gruppo Rubinetto DX	Complete Right Tap		2	
2	1200 0038	Galletto	Wing Nut	G1/2"	2	
3	2802 0018	Raccordo p.g. Mandata	Delivery Hose Tail	Ø8x10	2	
4	1209 0013	Guarnizione	Gasket	Ø12x18x2	2	
5	2826 0032	Rubinetto DX	Right Tap	G1/2-1/2"	2	
6	2806 0013	Raccordo Mandata	Delivery Hose Tail		3	
7	1210 0003	Guarnizione OR	O-Ring	Ø3x16,2	4	
8	0415 0009	Collettore Mandata	Delivery Manifold		1	
9	2826 0031	Rubinetto SX	Left Tap	G1/2-1/2"	1	
10	1209 0013	Guarnizione	Gasket	Ø12x18x2	1	
11	2802 0018	Raccordo p.g. Mandata	Delivery Hose Tail	Ø8x10	1	
12	1200 0038	Galletto	Wing Nut	G1/2"	1	
13	1214 0016	Gruppo Rubinetto SX	Complete Left Tap		1	
14	1816 0118	Manometro	Pressure Gauge	SR 50 bar - 1/4"	1	Solo / Only Con Valvola Regolazione With Regulation Valve
15	0102 0020	Kit Accumulatore Pressione	Pressure Accumulator kit		1	
16	0604 0008	Dado	Nut	M8	8	
17	0002 0008	Accumulatore Press. Infer.	Pressure Accumulator		1	
18	1800 0034	Membrana Accumulatore	Diaphragm		1	
19	0003 0018	Accumulatore Press. Sup.	Pressure Accumulator		1	
20	3607 0070	Vite Testa Esagonale	Hexagonal Screw	M8x30	8	
21	3610 0003	Valvola Aria	Air Valve		1	
22	1209 0033	Guarnizione	Gasket	Ø14x7,5x2	2	
23	1200 0005	Galletto	Wing Nut	30MB	1	
24	2801 0004	Raccordo p.g. Rifiuto Curvo	Elbow Tail	Ø18x23	1	
25	1210 0002	Guarnizione OR	O-Ring	Ø2,62x20,7	1	
26	2000 0012	Nipple	Nipple	M36x2-M30x2	1	
27	1210 0033	Guarnizione OR	O-Ring	Ø3x28	1	
28	3009 0042	Sede Valvola Pressione	Pressure Valve Seat		1	
29	0424 0072	Corpo Infer. Valvola Regol.	Regulation Valve Body		1	
30	3609 0047	Vite	Screw	M6x14	1	
31	1800 0039	Membrana Valvola Regolaz.	Regulation Valve Diaphragm		1	
32	3021 0011	Spina Elastica	Elastic Pin	Ø4x26	1	
33	1600 0014	Leva Valvola Regolazione	Lever		1	
34	1202 0002	Gancio Valvola Regolazione	Hook		1	
35	0015 0068	Asta Valvola Regolazione	Regulation Valve Rod		1	
36	1802 0085	Molla	Spring	Øe34x14	1	
37	0432 0022	Cappellotto Premi Molla	Special Cap		1	
38	0208 0002	Bilancere Valvola Regolaz.	Lever		1	
39	3605 0003	Vite Speciale Galletto	Wing Nut Screw		1	
40	1802 0010	Molla (Filo Ø2)	Spring (Wire Ø2)	Øe15x28	1	
41	3021 0011	Spina Elastica	Elastic Pin	Ø4x26	1	
42	1210 0033	Guarnizione OR	O-Ring	Ø3x28	1	
43	0424 0077	Corpo Super. Valvola Regol.	Regulation Valve Body		1	
44	3609 0157	Vite	Screw	M8x18	3	
45	3600 0020	Valvola Pressione	Pressure Valve		1	
46	0604 0050	Dado	Nut	G3/4x7	1	
47	1215 0287	Gruppo Valvola Regolazione	Regulation Valve Assembly		1	
48	3609 0091	Vite	Screw	M12x35	32	
49	3218 0009	Testata Pompa	Pump Manifold		4	
50	0602 0011	Disco Tenuta Membrana	Disc		4	
51	2419 0042	Prigioniero	Stud Bolt	12MBx30/11x11	4	
52	1800 0012	Membrana Pompa	Diaphragm	Gomma Nitrilica Buna Rubber	4	
52	1800 0058	Membrana Pompa	Diaphragm	Desmopan ®	4	
52	1800 0031	Membrana Pompa	Diaphragm	Viton ®	4	
53	0400 0017	Camicia	Piston Sleeve	Ø70x20,5	4	
54	0020 0001	Anello Compressione	Compression Ring	Ø70x3x2,8	4	
55	3020 0006	Seeger Interno	Inner Seeger	Ø18	8	
56	3011 0003	Spinotto	Gudgeon Pin	Ø18x57	4	
57	2409 0068	Pistone Guida	Piston	Ø70	4	
58	0205 0023	Kit Biella 4SET	Connecting Rod Assembly		1	
59	1210 0002	Guarnizione OR	O-Ring	Ø2,62x20,7	1	
60	0402 0288	Coperchio Infer. Comp. Vol.	Cover		1	
61	1210 0213	Guarnizione OR	O-Ring	Ø3,53x82,14	1	
62	1809 0006	Murata Compensatore Vol.	Holder		1	
63	1210 0067	Guarnizione OR	O-Ring	Ø2,62x55,25	1	
64	0421 0001	Compensatore Volumetrico	Volumetric Compensator		1	
65	1800 0001	Membrana Compens. Volum.	Volum. Comp. Diaphragm		1	
66	0402 0522	Coperchio Compens. Volum.	Volum. Compensator Cover		1	
67	1208 0019	Gruppo Compensatore Vol.	Volumetric Compensator		1	
68	0438 0003	Cuscinetto a Sfere	Ball Bearing	Ø40x110x27	1	
69	2813 0011	Rondella Tenuta Biella	Connecting Rod Washer	Ø40,5x128	1	
70	0010 0004	Anello Tenuta Biella	Connecting Rod Ring	Ø129,5x110x10	1	
71	0437 0006	Cuscinetto Rulli	Roller Bearing	Ø65x95x28	2	

### 550 RPM

N°	Cod.	Descrizione	Description	Note	Qty	Model
72	0001 0038	Albero Passante	Throughshaft	1"3/8 M-M	1	
73	0010 0004	Anello Tenuta Biella	Connecting Rod Ring	Ø129,5x110x10	1	
74	2813 0011	Rondella Tenuta Biella	Connecting Rod Washer	Ø40,5x128	1	
75	0438 0003	Cuscinetto a Sfere	Ball Bearing	Ø40x110x27	1	
76	1210 0092	Guarnizione OR	O-Ring	Ø1,78x126,72	1	
77	0405 0021	Coperchio Supp. porta Cusc.	Support Cover		1	
78	3607 0221	Vite Testa Esagonale	Hexagonal Screw	M10x20	6	
79	3020 0011	Seeger Interno	Inner Seeger	Ø60	1	
80	0019 0068	Anello Tenuta	Oil Seal	Ø40x60x10	1	
81	1200 0004	Galletto	Wing Nut	M46x2 - Ø35	1	
82	2801 0001	Raccordo p.g. Aspir. Curvo	Suction Elbow Tail	Ø27x35	1	
83	3212 0006	Tubo Aspirazione	Suction Hose		1	
84	1210 0020	Guarnizione OR	O-Ring	Ø3,53x20,22	8	
85	2804 0007	Raccordo Curvo Aspirazione	Elbow Suction Coupling		4	
86	3213 0002	Tubo Aspirazione	Suction Hose		3	
87	0418 0004	Cavallotto	U-Bolt		8	
88	3609 0160	Vite	Screw	M10x30	8	
89	1220 0010	Gruppo Valvola Asp./Mand.	Suct./Delivery Valve Ass'y kit		8	
90	1209 0043	Guarnizione	Gasket	Ø29x42x1,8	8	
91	3009 0123	Sede Valvola Aspir./Mand.	Suction/Delivery Valve Seat		8	
92	3604 0009	Valvola Aspiraz./Mandata	Suction/Delivery Valve		8	
93	1802 0015	Molla (Filo Ø0,8)	Spring (Wire Ø0,8)	Øe11x17	8	
94	1205 0005	Gabbia Valvola Aspir./Mand.	Suction/Delivery Valve Cage		8	
95	0403 0138	Carter Pompa	Pump Crankcase		1	
96	1210 0209	Guarnizione OR	O-Ring	Ø2x19	1	
97	3200 0001	Tappo Esagonale	Plug	22MB	1	
98	2400 0011	Piede Sostegno Pompa	Pump Mounting Bracket		2	
99	0019 0068	Anello Tenuta	Oil Seal	Ø40x60x10	1	
100	3020 0011	Seeger Interno	Inner Seeger	Ø60	1	
101	3607 0220	Vite Testa Esagonale	Hexagonal Screw	M10x30	6	
102	2806 0017	Raccordo Mandata per Valv.	Delivery Hose Tail for Valve		1	
103	1211 0012	Gomito	Elbow		1	
104	1219 0041	Gruppo Valvola Sicurezza	Safety Valve Assembly	50 bar 100-150L	1	

#### Varianti

##### Version

110	0001 0048	Albero	Shaft	1"3/8M-Ø32 Cil.	1	
111	0405 0044	Flangia Porta Paraolio	Flange		1	

#### Varianti

##### Version

112	0800 0005	Eccentrico	Eccentric		1	
113	2813 0013	Rondella Tenuta Biella	Connecting Rod Washer	Ø55x128	1	
114	0004 0002	Albero	Shaft		1	
115	1602 0008	Linguetta	Key	12x8x40	1	
116	0438 0014	Cuscinetto a Sfere	Ball Bearing	Ø75x130x25	1	
117	0019 0001	Anello Tenuta	Oil Seal	Ø68x90x10	1	
118	1004 0003	Flangia Porta Paraolio	Flange		1	
119	3621 0004	Vite Speciale	Special Screw	M8x14	2	

#### Kit

##### Optional

120	5001 0027	Kit Puleggia	Pulley Kit	3B - Øp292	1	
121	2424 0012	Puleggia	Pulley	3B - Øp292	1	
122	3607 0227	Vite Testa Esagonale	Hexagonal Screw	M10x40	3	

#### Kit

##### Optional

123	5001 0028	Kit Puleggia	Pulley Kit	3A - Øp350	1	
124	2424 0005	Puleggia	Pulley	3A - Øp350	1	
125	3609 0009	Vite	Screw	M10x35	3	

#### Kit Manutenzione

##### Maintenance Kit

130	5026 0095	Kit Manutenzione Ordinaria	Ordinary Maintenance Kit		1	
-----	-----------	----------------------------	--------------------------	--	---	--